

# RoHS

| REV | ECN NO. | DESCRIPTION | DESIGN | APPROVAL | DATE       |
|-----|---------|-------------|--------|----------|------------|
| A1  | NEW     | 更换图框        |        |          | 2023.11.25 |

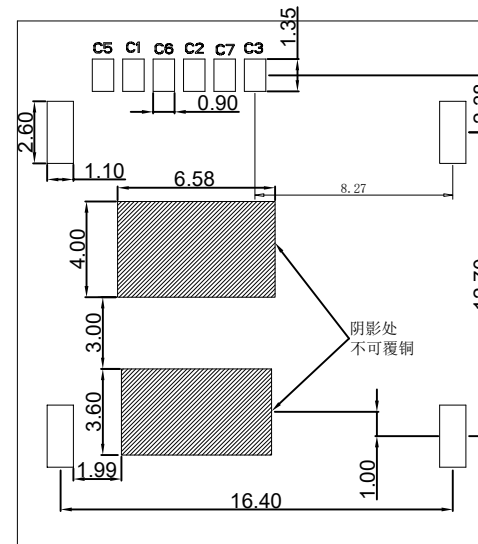
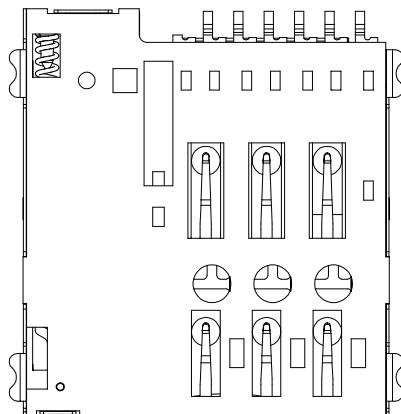
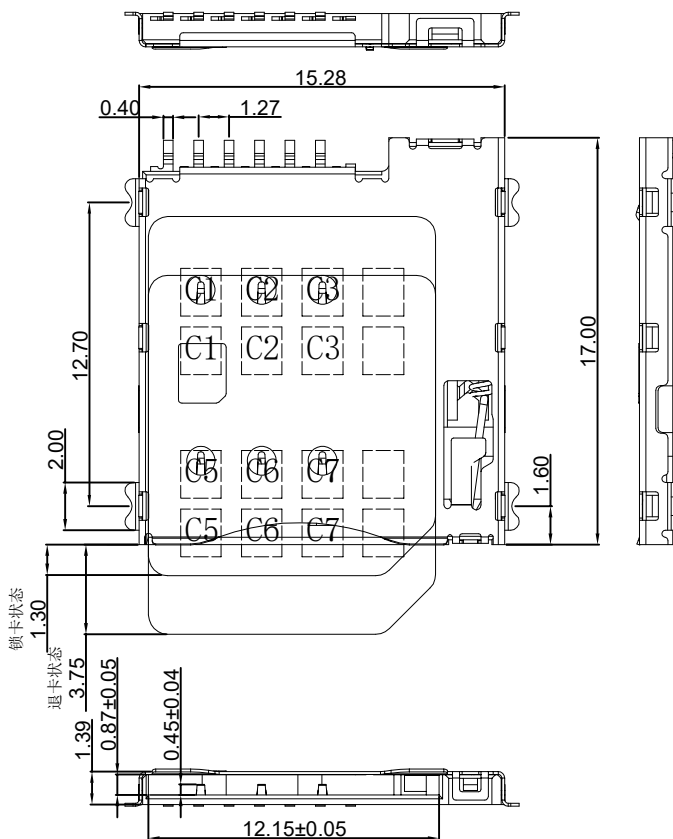

**NOTES:**

**1.MATERIAL:**

HOUSING:LCP S475 UL 94V-0  
CONTACT:C5191  
SHELL:SUS304-H

**2.FINISH:**

CONTACT:GOLD FLASH PLATED ON CONTACT AREA  
GOLD FLASH PLATED ON SOLDER TAILS

**3.ELECTRICAL CHARACTERISTICS**

RATING CURRENT : 0.5A MAX  
CONTACT RESISTANCE :50 mΩ MAX  
DIELECTRIC WITHSTANDING : 500V AC MIN  
INSULATION RESISTANCE: 1000 MΩ MIN

**4.MECHANICAL CHARACTERISTICS**

MATING CYCLE :3000 CYCLES

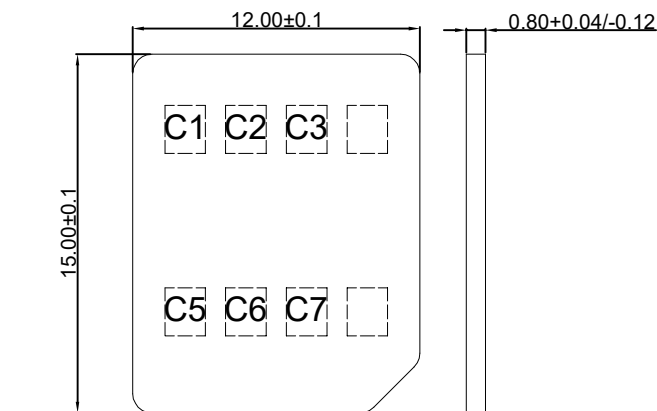

| SIM pin Assignment |      |
|--------------------|------|
| PIN#               | Name |
| C1                 | VCC  |
| C2                 | RST  |
| C3                 | CLK  |
| C5                 | GND  |
| C6                 | VPP  |
| C7                 | I/O  |

|             |        |
|-------------|--------|
| X. 0. 3     | X.°±   |
| . X±0. 2    | .X°±   |
| . XX±0. 08  | .XX°±  |
| . XXX±0. 03 | .XXX°± |
| UNITS:      | mm     |

THESE DRAWINGS AND SPECIFICATIONS ARE THE PROPERTY OF XFCN AND SHALL NOT BE REPRODUCED, COPIED OR CUED IN ANY MANNER WITHOUT THE PRIOR WRITTEN CONSENT OF XFCN

|          |                |                        |       |                   |  |
|----------|----------------|------------------------|-------|-------------------|--|
| PART NO: |                | MIS11-S1F1-2000-A      |       | <b>XFCN</b> 兴飞连接器 |  |
| TITLE:   |                | MICRO SIM PUSN卡座 (无CD) |       | 0769-82001899     |  |
|          |                |                        |       | www.xfconn.com    |  |
|          |                |                        |       | DWG NO: /         |  |
| APPD     | Chen ZhiQiang  | VIEW                   |       |                   |  |
| CHKD     | Liu Wei        | SCALE                  | SHEET | REV               |  |
| DRAW     | Chen HongJiang | NONE                   | 1/2   | A1                |  |
| DATE     | 2024.08.19     |                        |       |                   |  |

# RoHS

| REV | ECN NO. | DESCRIPTION | DESIGN | APPROVAL | DATE       |
|-----|---------|-------------|--------|----------|------------|
| A1  | NEW     | 更换图框        |        |          | 2023.11.25 |

| QTY/REEL | REEL/CARTON | QTY/CARTON |
|----------|-------------|------------|
| 1200     | 10          | 12000      |

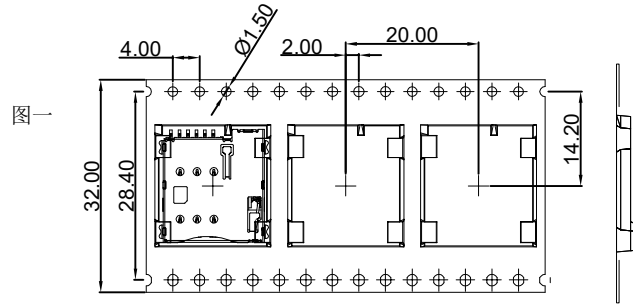

图三

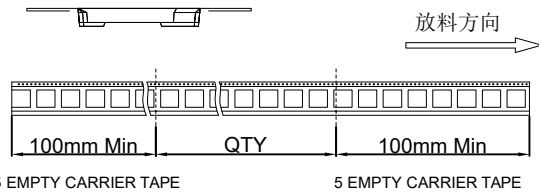

5 EMPTY CARRIER TAPE

5 EMPTY CARRIER TAPE

放料方向

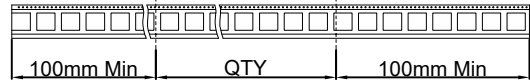

COVER TAPE PEELING FORCE:50gf-150gf

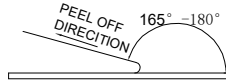

PEEL OFF DIRECTION 165°-180°

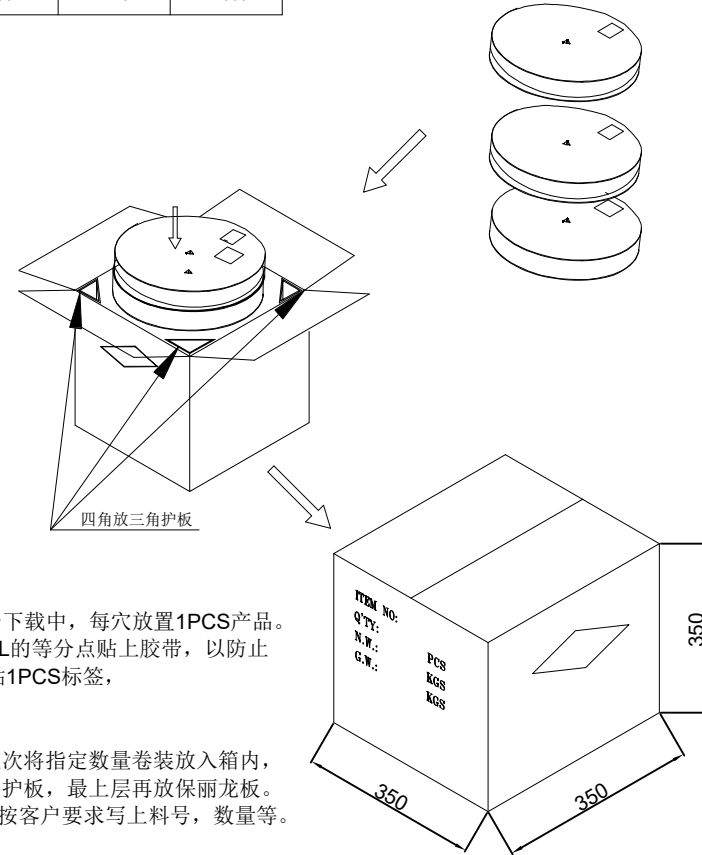

- 依(图一)示放置产品于下载中, 每穴放置1PCS产品。
- 包装机包好后, 在REEL的等分点贴上胶带, 以防止REEL张开, 每REEL贴1PCS标签,
- 包装数量见如TABLE 1
- 包装成箱见如图三  
箱底放保丽龙板, 在依次将指定数量卷装放入箱内, 四角分别放入四个三角护板, 最上层再放保丽龙板。
- 封箱, 在封好的纸箱上按客户要求写上料号, 数量等。

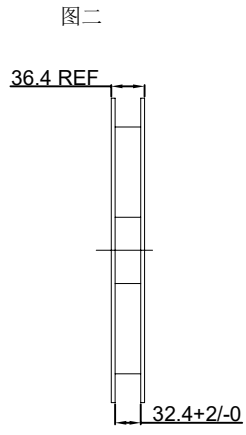

LABLE

| X. 0. 3  | X. ° ±    | PART NO:<br>MIS11-S1F1-2000-A | <b>XFCN</b> 兴飞连接器 |       |                                  |                |  |
|--|-----------|-------------------------------|-------------------|-------|----------------------------------|----------------|--|
| . X ± 0. 2   | . X ° ±   |                               |                   |       | TITLE:<br>MICRO SIM PUSN卡座 (无CD) | 0769-82001899  |  |
| . XX ± 0. 08   | . XX ° ±  |                               |                   |       |                                  | www.xfconn.com |  |
| . XXX ± 0. 03  | . XXX ° ± |                               |                   |       |                                  | DWG NO: /      |  |
| UNITS:   | mm        | APPD                          | Chen ZhiQiang     | VIEW  |                                  |                |  |
| THESE DRAWINGS AND SPECIFICATIONS ARE THE PROPERTY OF XFCN AND SHALL NOT BE REPRODUCED, COPIED OR CUED IN ANY MANNER WITHOUT THE PRIOR WRITTEN CONSENT OF XFCN |           | CHKD                          | Liu Wei           | SCALE | SHEET                            |                |  |
|  |           | DRAW                          | Chen HongJiang    |       | REV                              |                |  |
|  |           | DATE                          | 2024.08.19        | NONE  | 2/2                              | A1             |  |
|  |           |                               |                   |       |                                  |                |  |